

Decore Single Arm Operator (Sill Mount)

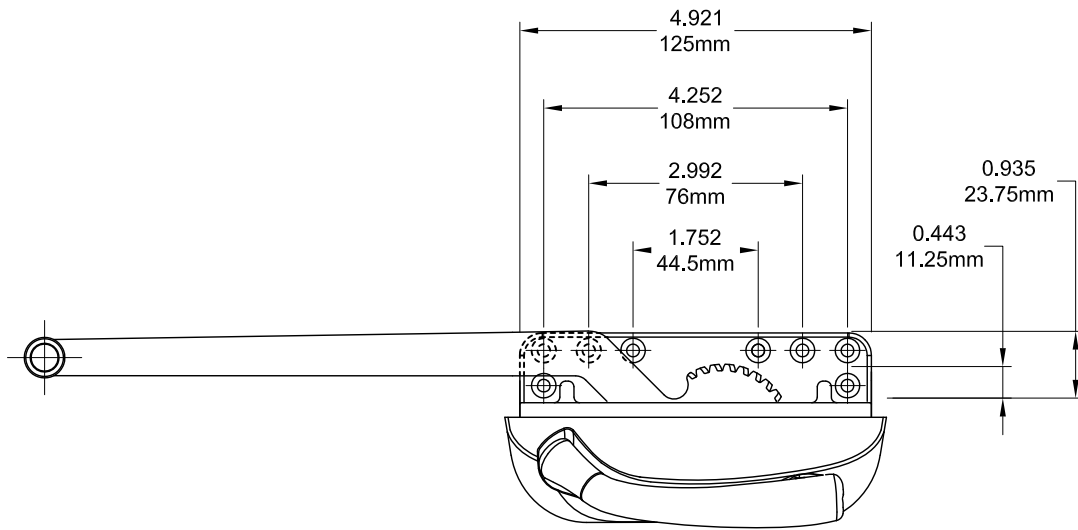

132635 - LZ
Left Hand Shown

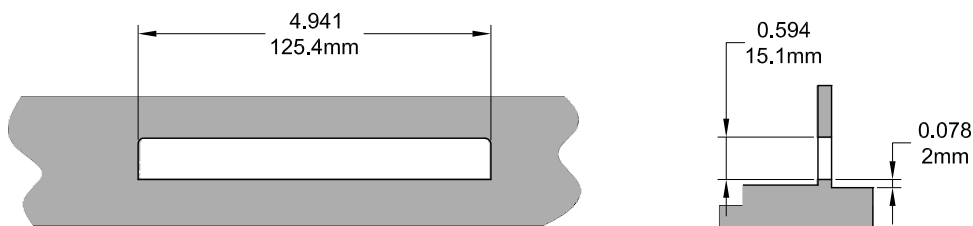
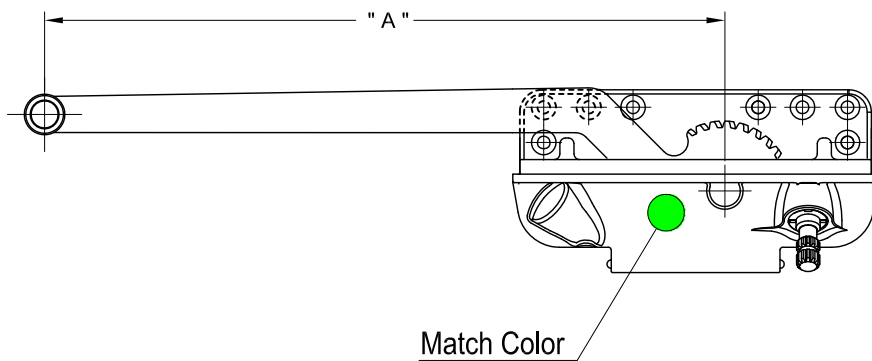

Profile Cut Out

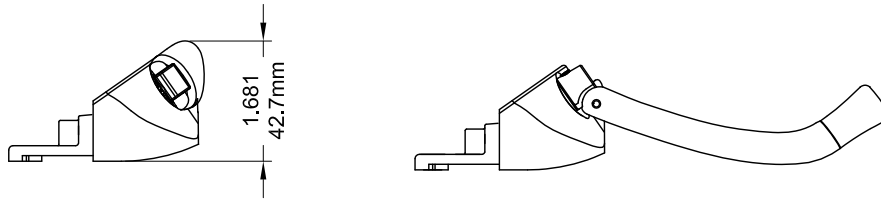

Product Name	Part Number	A (Arm Length)	Match Color
Decore Single Arm Operator 7.5" , LH	132635-LZ75X	7.5"	Green
Decore Single Arm Operator 7.5" , RH	132635-RZ75X	7.5"	Red
Decore Single Arm Operator 9.5" , LH	132635-LZ95X	9.5"	Green
Decore Single Arm Operator 9.5" , RH	132635-RZ95X	9.5"	Red
Decore Single Arm Operator 13.5" , LH	132635-LZ135X	13.5"	Green
Decore Single Arm Operator 13.5" , RH	132635-RZ135X	13.5"	Red

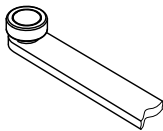

<1> Nylon Glide Shoe

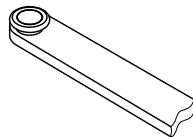

<2> SST Roller

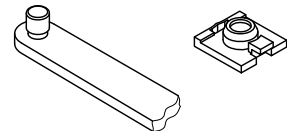

<3> Plastic Slider

- <1> This is default, in this case, no letter attached
- <2> "X" = S Stands for SST Roller
- <3> "X" = P Stands for Plastic Slider

Cover and Crank Match Color

Part Number	Match Color
132066R1	Green
132067R1	Red

132066R1 Shown

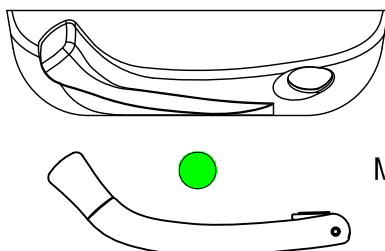

132067R1 Shown

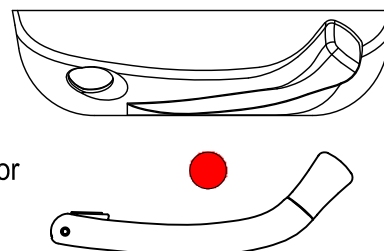

Match Color

Back Plate

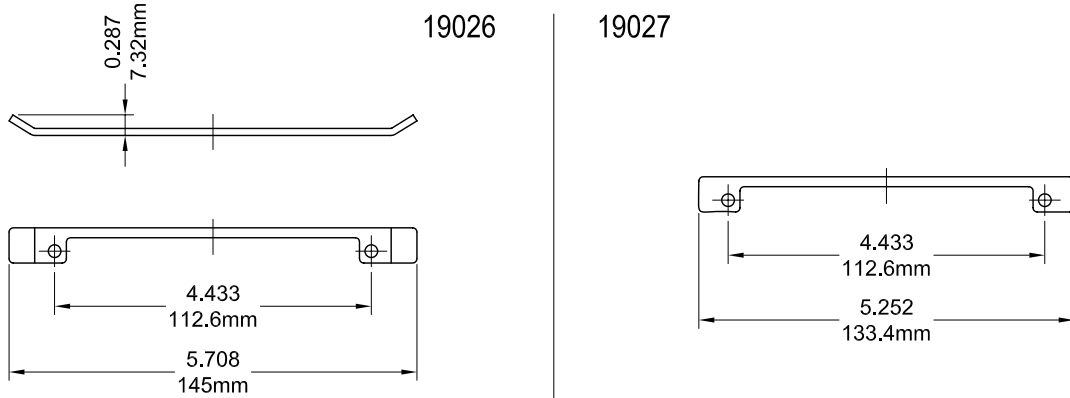

Track

<1>

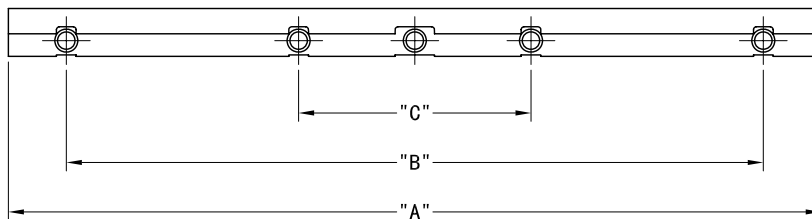
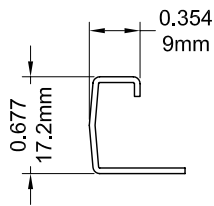

Single Arm Operator Track				
Part Number	" A "	" B "	" C "	Material
70039	8.874"	6.504"	N/A	SST
190039				Steel
70040	11.378"	9.756"	3.252"	SST
190040				Steel
70041	13.752"	12.374"	4.126"	SST
190041				Steel

<2>

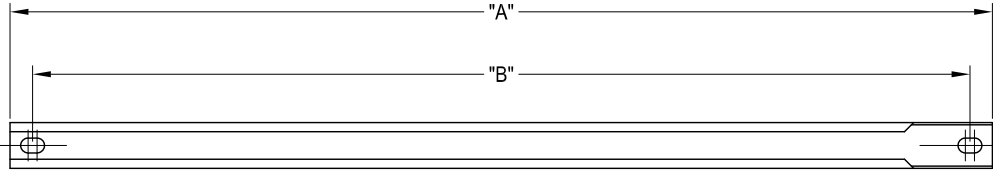
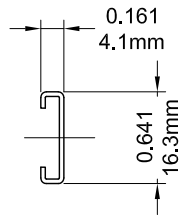

Single Arm Operator Track 2 Holes			
Part Number	" A "	" B "	Material
70054	9.5"	8.87"	SST
70055	13.75"	13.12"	SST
70056	17.795"	17.165"	SST

<3>

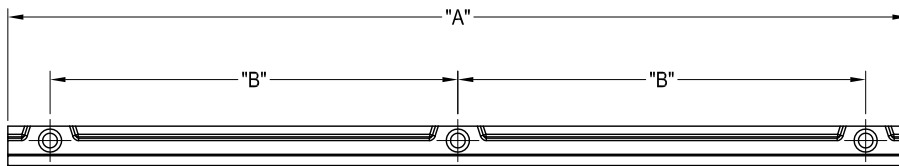
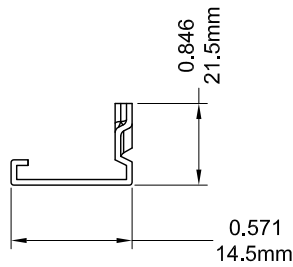

Dual Arm Operator Track 3 holes			
Part Number	" A "	" B "	Material
70051R1	14.449"	6.496"	SST
190051R1			Steel
70052R1	12.598"	5.708"	SST
190052R1			Steel
70053R1	11.811"	5.315"	SST
190053R1			Steel